







Corr-Vac[®] MAP-VAC

MODIFIED ATMOSPHERE PACKAGING (M.A.P.) or Controlled Vacuum Packaging is at the heart of every unit CV-TEK manufactures. We preserve, protect and extend the shelf life of your products. Whether it is individual bags, lined cases, bulk-bin, totes, Gaylords, barrel, or super-sacks, CV-TEK has a proven solution.

Fresh Product MAP Benefits:

-  Extended Shelf Life
-  Preservation of Flavor
-  Lower Ship Weight vs Ice Pack
-  Increased Distribution Area
-  Reduced Energy Cost
(Eliminate Freeze/Defrost)

MAP-VAC is perfect for these and other applications

POULTRY | BEEF & PORK | FISH | PREPARED MEATS | CHEESE | NUTS
PRODUCE & FRESH-CUT | POWDERS | ORGANICS | INDUSTRIAL

Corr-Vac® MAP-VAC

The Corr-Vac® Modified Atmosphere Packaging Machine has a 1355mm/53.5" peatable seal pressure. Wrinkles and gussets are no longer an issue, the MAP-VAC simply seals right through them.

With Twin Teflon® gas-flush/vacuum probes at 9.25" or 15 inch spacing, the unit opens easily and can be 100% sanitized.



Electrical, pneumatics & vacuum pump in separate waterproof compartments

Corr-Vac® MAP-VAC Features:

- ▶ 100% stainless steel and FSMA, FDA, & USDA compliant, optional 3A dairy-grade
- ▶ Built-to IP69 specifications, ensuring IP67 compliance wash-down ready
- ▶ Seal bar lengths available 30, 54, and 62-inch
- ▶ B & R Controls
- ▶ Flexible probes reduce damage and extend life
- ▶ Multiple language options available on our easy to operate controller
- ▶ Floor mount, optional casters, or unit can be suspended over a conveyor
- ▶ Vacuum pump or optional liquid-ring and venturi
- ▶ Hot-bar or impulse sealing
- ▶ Bag-stretcher option to ensure wrinkle free bags
- ▶ One or two hand control options

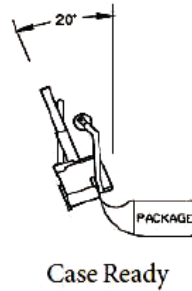
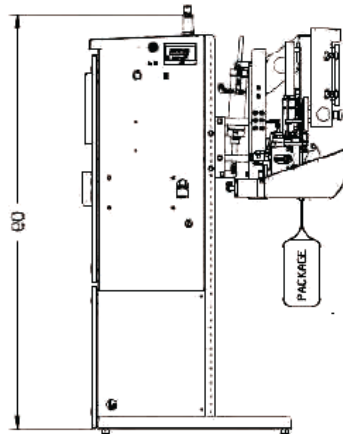
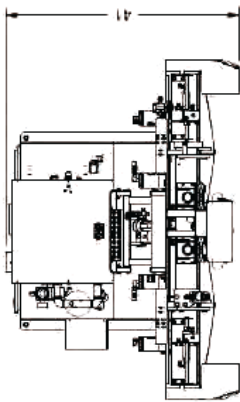

Case Ready

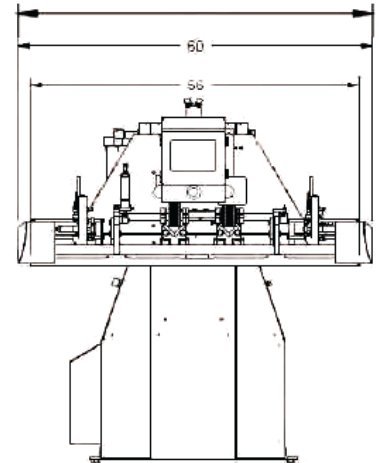

CV-TEK PRODUCTS



MARKIII



BULK-BIN



MHSP



VFFS

