





MARK III mHSP MULTI-STATION MAP



MODIFIED ATMOSPHERE PACKAGING (M.A.P.)
or Controlled Vacuum Packaging is at the heart of every unit CV-Tek manufactures. We preserve, protect and extend the shelf life of your products. Whether it is individual bags, lined cases, bulk-bin, totes, Gaylords, super-sacks, or barrels CV-Tek has a proven solution.

Fresh Product MAP Benefits:

-  Extended Shelf Life
-  Preservation of Flavor
-  Lower Ship Weight vs Ice Pack
-  Increased Distribution Area
-  Reduced Energy Cost
(Eliminate Freeze/Defrost)

MARK III mHSP is built for these and other applications

POULTRY | BEEF & PORK | FISH | PREPARED MEATS | CHEESE | NUTS
PRODUCE & FRESH-CUT | POWDERS | ORGANICS | INDUSTRIAL

MARKIII mHSP

The Corr-Vac mHSP MAP has an automatic case in-feed, positioning, & out-feed. Single employee operation of 3-modules. Easy to change M.A.P. to controlled vacuum packaging, to seal 1-4 bags & master outer bags

The 2, 3, 4 or more stations give unprecedented flexibility & high M.A.P. packaging speeds

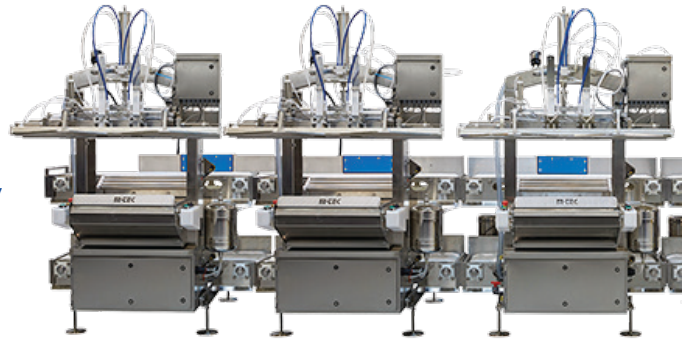

Available in 2, 3, 4 or more stations

MARKIII mHSP - Features:

ENTIRE UNIT

- ▶ 100% stainless steel and FSMA, FDA, & USDA compliant, optional 3A dairy-grade
- ▶ Built-to IP69 specifications, ensuring IP67 compliance wash-down ready

EACH MODULE

- ▶ 54" stainless steel hot bar sealing system with cool-edge and Teflon® tape
- ▶ Easy open twin Teflon® vacuum/gas flush probes allow 100% sanitation & inspection
- ▶ Smart-belt infeed and discharge conveyor. No stop & start degradation.
- ▶ Stainless steel gas accumulator tank optimizes cycle time with side mounted Cuno filter
- ▶ One enclosed 38 CFM vacuum pump per head (add H₂O ring pumps or venturi air-pumps)
- ▶ Independent operation - if one module goes down, remaining modules continue to run

- Frame:** Solid 7-gauge polished stainless steel (2B finish)
- Belts:** 18-inch standard (46cm)
- Case:** 10 - 90 lbs. Up to 15.25"H (4.5kg - 41kg/39cm)
- Power:** 480VAC - 20 amps/ 3 ph/ 60 hz - standard
- Air:** 5 cfm @ 90 psi - one 3/4" line
- Gas:** (CO₂, N) : one - 1" line at 100 psi
- Speed:** 3 to 4 cases per minute per module

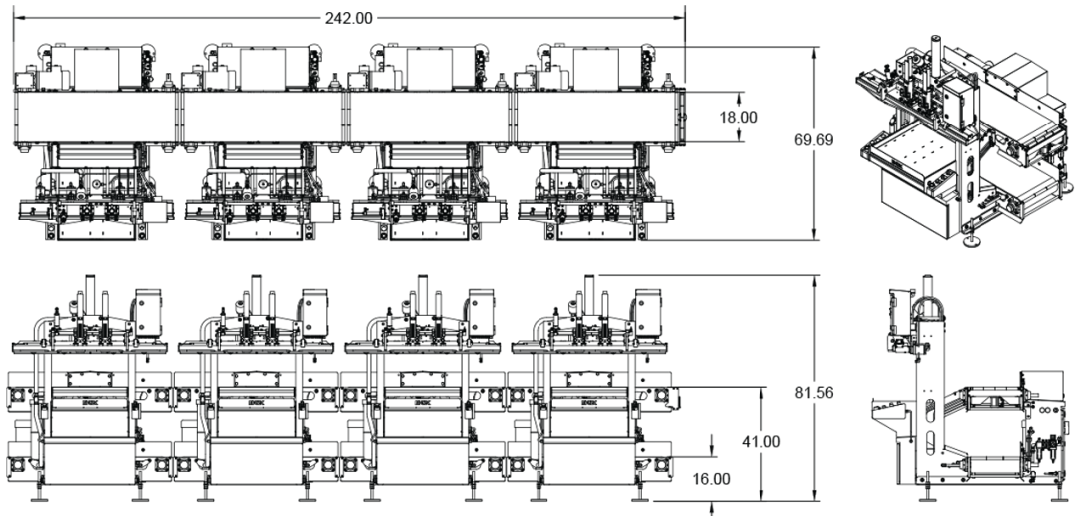

CV-TEK PRODUCTS



MAP-VAC



BULK BIN



MARKIII



VFFS

