

MARK III Bulk-Bin







MARK III ROLL-AROUND

MARK III SUSPENDED

MODIFIED ATMOSPHERE PACKAGING (M.A.P.) or Controlled Vacuum

Packaging is at the heart of every unit CV-TEK manufactures. We preserve, protect and extend the shelf life of your products. Whether it is individual bags, lined cases, bulk-bin, totes, Gaylords, supersacks, or barrels CV-TEK has a proven solution.

Fresh Product MAP Benefits:

-  Extended Shelf Life
-  Preservation of Flavor
-  Lower Ship Weight vs Ice Pack
-  Increased Distribution Area
-  Reduced Energy Cost
(Eliminate Freeze/Defrost)

Bulk-Bin is perfect for these and other applications

POULTRY | BEEF & PORK | FISH | PREPARED MEATS | CHEESE | NUTS
PRODUCE & FRESH-CUT | POWDERS | ORGANICS | INDUSTRIAL

MARK III Bulk-Bin

MARK III Bulk-Bin - Features:

- ▶ 100% stainless steel and FSMA, FDA, & USDA compliant, optional 3A dairy-grade
- ▶ Built-to IP69 specifications, ensuring IP67 compliance wash-down ready
- ▶ Seal bar lengths available 30, 54, and 62-inch
- ▶ Flexible probes reduce damage and extend life
- ▶ Multiple language options available on our easy to operate controller
- ▶ Floor mount, optional casters, or unit can be suspended over a conveyor
- ▶ Vacuum pump or optional liquid-ring and venturi
- ▶ Hot-bar or impulse sealing
- ▶ Bag-stretcher option to ensure wrinkle free bags
- ▶ One or two hand control options

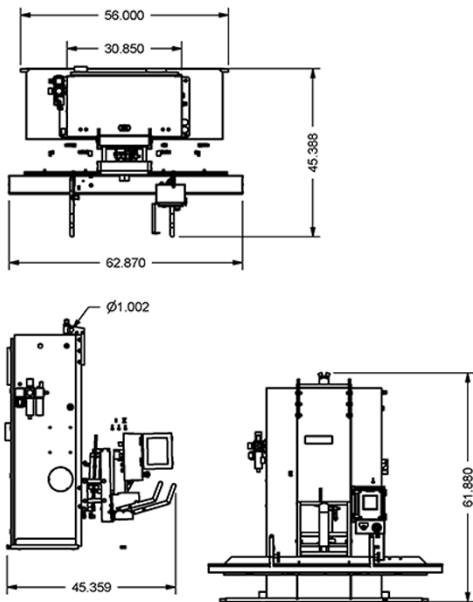

MARK III Bulk-Bin | Suspended

The weight of the MARK III machine is approximately 700 lbs. Total weight provision must include the product and bin. Installation should meet local, state, and federal guidelines and acceptable practices.

Operator education, frequent inspection, maintenance, and documentation of all parts is a requirement for continued safe operation of the overhead lifting system.

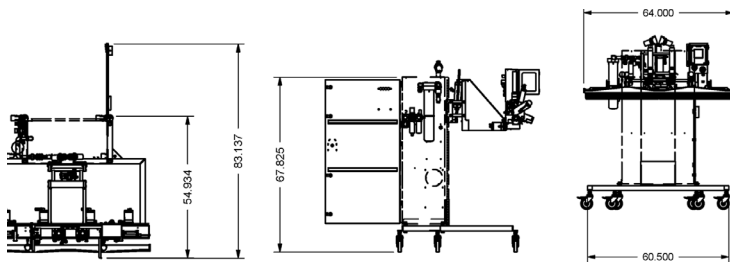

MARK III Bulk-Bin | Roll-Around

CV-TEK PRODUCTS



MAP-VAC



MHSP



MARK III



VFFS

